



Simulation and Comparison of the Performance of Refrigerant Fluids in Single Stage Vapour Compression Refrigeration System

T. S. Mogaji^{1*}

¹*Department of Mechanical Engineering, Federal University of Technology Akure, School of Engineering and Engineering Technology, P.M.B. 704, Ondo State, Nigeria.*

Author's contribution

The sole author designed, analyzed, interpreted and prepared the manuscript.

Article Information

DOI: 10.9734/BJAST/2015/16778

Editor(s):

- (1) Elena Lanchares Sancho, Department of Mechanical Engineering, University of Zaragoza, Zaragoza, Spain.
(2) Manoj Gupta, Department of Mechanical Engineering, NUS, 9 Engineering Drive 1, Singapore 117576, Singapore.

Reviewers:

- (1) Anonymous, Maejo University, Thailand.
(2) Anonymous, Panimalar Engineering College, India.
(3) Alcinia Zita Sampaio, Technical University of Lisbon, Lisbon, Portugal.
(4) Irene Samy Fahim, Mechanical Engineering, American University in Cairo, Egypt.
(5) João Batista Campos Silva, Department of Mechanical Engineering, UNESP, Brazil.
Complete Peer review History: <http://www.sciencedomain.org/review-history.php?iid=1074&id=5&aid=9151>

Original Research Article

Received 13th February 2015

Accepted 16th April 2015

Published 8th May 2015

ABSTRACT

This paper presents reports on simulation and comparative analysis of single stage vapour compression refrigeration system performance for comparison of refrigerant fluids. A mathematical model was devised by applying the concept of energy balance in the thermodynamic cycle to the components of the vapour compression refrigeration system. The developed model implemented in MATLAB [1] software was used to compare the performance of the system using Hydrocarbons, R134a and ammonia as refrigerants in place of refrigerants 12 and 22. Simulation data was generated over a wide range of evaporation and condensation temperatures of -25 to 15°C and 30 to 60°C respectively for the selected working fluids considered in this study to observe the performance of the system in terms of refrigerating effect, coefficient of performance (COP) and overall efficiency of the system. In the present study, close match of COP and the system overall efficiency values for R134a, R290 and R600a are observed with that of R12 and R22 counterparts under the similar operating conditions. Moreover, among the refrigerants simulated in the system under the similar operating conditions, the system with the use of ammonia yields highest COPs

*Corresponding author: E-mail: mogajits@gmail.com;

and are of up to 6.3 and 7.5% increment compared with those of R12 and R22 respectively. It can be concluded that R134a, R290, R600a and ammonia may act as substitutes for R12 and R22 without affecting the energy efficiency of vapour compression refrigeration system, provided the safety issues are addressed in terms of manufacturing, handling, storage and servicing so as to prevent flammability and corrosive/toxic natures of both hydrocarbons and ammonia refrigerants respectively, thus helping to solve the ozone depletion potential (ODP) and global warming potential (GWP) problems regarding environmental issues.

Keywords: Vapour compression refrigeration system; refrigerant; coefficient of performance (COP); refrigerating effect; overall efficiency of the system.

1. INTRODUCTION

Vapour compression refrigeration system based applications make use of refrigerants such as chlorofluorocarbons (CFCs) and hydro chlorofluorocarbons (HCFCs) which are responsible for greenhouse gases, global warming and ozone layer depletion effects. These effects cause a lot of ill health and diseases for living beings. These refrigerants have been used widely over the last eight decades in refrigeration and air-conditioning systems due to their favourable characteristics such as low freezing point, non-flammability, non-toxicity and chemically stable behaviour with other materials, Mohan [2]. The role of these refrigerants in the process of ozone depletion is now widely accepted, this is due to high chlorine content of these substances. The relationship between ozone depletion potential and global warming potential is the major concern in the field of GRT (green refrigeration technology). As pointed out in the study of Dalkilic and Wongwises [3], ozone depletion potential and global warming potential have become the most important criteria in the development of new refrigerants. This had lead researchers to have started focusing on investigation into more environmental friendly refrigerants than CFCs and HCFCs refrigerants for the protection of the environment such as the use of R134a, ammonia and hydrocarbon (HC) refrigerants as working fluid in refrigeration and air-conditioning systems. Hydrocarbon refrigerants have the advantages of low local availability and environmental acceptability when compared to CFCs and HCFCs. This is due to the fact that, the absence of chlorine in Hydrocarbon (HC) and ammonia results in zero ozone depleting potential (ODP) and has a negligible global warming potential (GWP). The studies according to Kalla and Usmani [4] also provide a review of the efforts to replace the HFCs (hydrofluorocarbons) which are harmful to the environment. The performance of a vapour compression refrigeration system can

be improved in a number of ways, other than by testing the system in a controlled environment experimentally; one of those ways is the use of computer models to simulate the thermal and fluid-dynamic behaviour of refrigeration systems to achieve rapid and accurate result that will aid optimum design of the system.

Application of simulation performance prediction and optimum design of refrigeration systems has been pointed out in the study of Guo-liang Ding [5]. Simulation techniques have also been used by researchers for design of vapour compression refrigeration system under steady-state conditions (Sanaye and Malekmohammadi [6]). According to Winkler [7], a steady-state simulation provides details regarding the system performance at a set of design points and describes how the system will perform at off-design conditions. Raghunatha Reddy et al. [8] carried out investigation on application of soft computing techniques for analysis of vapour compression refrigeration system. The result from their study revealed that intelligent systems such as autonomous self-tuning systems and automated designed systems are applicable with the aids of computer simulation techniques. Many investigations have been carried out both experimentally and numerically in search for more eco-friendly refrigerants that could be retrofitted to existing vapour compression refrigeration system so as to minimize adverse impact of thermal systems usage on the environment. Tallita et al. [9] developed a mathematical model using adaptive time step Runge-Kutta Fehlberg fourth-fifth order method to compare the performance of vapour compression refrigeration system substituting R12 for R134a, ammonia and R600a. The simulation results of their study revealed R134a as the best fluid that could be used to replace R12 in vapour compression refrigeration system. Mohan [2] reported comparative analysis of the refrigerant impact on the operation and performances of a one stage vapour

compression refrigeration system using R12 and R134a as refrigerants. According to the author, R134a is observed to be more sensitive to variation in degree of sub-cooling from COP evaluation point of view. Hadya et al. [10] studied and compared theoretically the possibility of using R32 and R290 refrigerants with R22 in a lower capacity air-conditioning system. Close match of COP values for R290 and R32 are observed with that of R22 counterpart based on the experimental operating conditions considered in their study.

To prevent the environmental damage and to reduce the harmful effects of the CFCs and HCFCs application in refrigeration industry further investigation are carried out in the present study using computer model to simulate fluid-dynamic behaviour of alternate refrigerants in refrigeration systems. Simulation and comparative analysis of performance of R134a, R290, R600a and ammonia as refrigerants in a single stage vapour compression system was carried out. The performance evaluation of the system in terms of COP, refrigerating effect and overall efficiency of the system values obtained for R134a, HCs and ammonia refrigerants were comparatively analysed with that of CFCs and HCFCs refrigerants.

2. VAPOUR COMPRESSION REFRIGERATION SYSTEM DESCRIPTION

Fig. 1 shows schematic diagram of a single stage vapour compression refrigeration system and the corresponding P-h diagram of the system is presented in Fig. 2. This system consists of a compressor, a condenser, expansion valve (capillary tube) and an evaporator. The arabic numbers in Fig. 1 from 1 to 4 show the different state of the vapour compression refrigeration system and the number sequence indicates the flow direction of refrigerant in the system. The refrigerant enters the compressor at state 1, as saturated vapor and also with respect to the evaporation temperature. It follows the irreversible compression process 1-2. At state 2 the refrigerant is with extremely high pressure and superheated. The compressed refrigerant vapor runs from state 2 to state 3. The refrigerant vapor at state 2 influxes into the condenser to be condensed and takes place the heat exchange with the surroundings hence arriving in state 3 as saturated liquid which is further throttled at constant enthalpy during the process 3-4. The cycle is closed by a vaporization process 4-1 in which the refrigerant (two-phase mixture) is

evaporated at constant pressure heat interaction in internally reversible condition to a saturated vapor at state 1. The process of the evaporation of refrigerant in the evaporator thus receives heat from the cooling / refrigerated space.

3. MATHEMATICAL MODEL

In this section the system components level mathematical models were developed based on the mass and energy conservation principles described as follows:

3.1 Refrigeration System Cooling Load Model

In the present study, the system cooling load (Q_{CL}) which comprises of both the product load (Q_{PT}) and the infiltration load (Q_I) is modelled as follows:

$$Q_{CL} = Q_{PT} + Q_I \quad (1)$$

where Q_{PT} is the total product cooling load estimated such that for n product stored in the system, the total product cooling load is calculated as:

$$Q_{PT} = \sum_1^n Q_P \quad (2)$$

The term Q_P in Eq. (2) is the total load required to cool a product from storage temperature T_i to final temperature T_3 and is determined using Eq. (3):

$$Q_P = Q_{AF} + Q_F + Q_{BF} \quad (3)$$

where the terms Q_{AF} , Q_F and Q_{BF} are defined as sensible heat load above freezing, latent heat of freezing, and sensible heat load below freezing respectively for the selected products and they are given as follow:

$$Q_{AF} = mc_a(T_1 - T_2) \quad (4)$$

$$Q_F = mh_{fg} \quad (5)$$

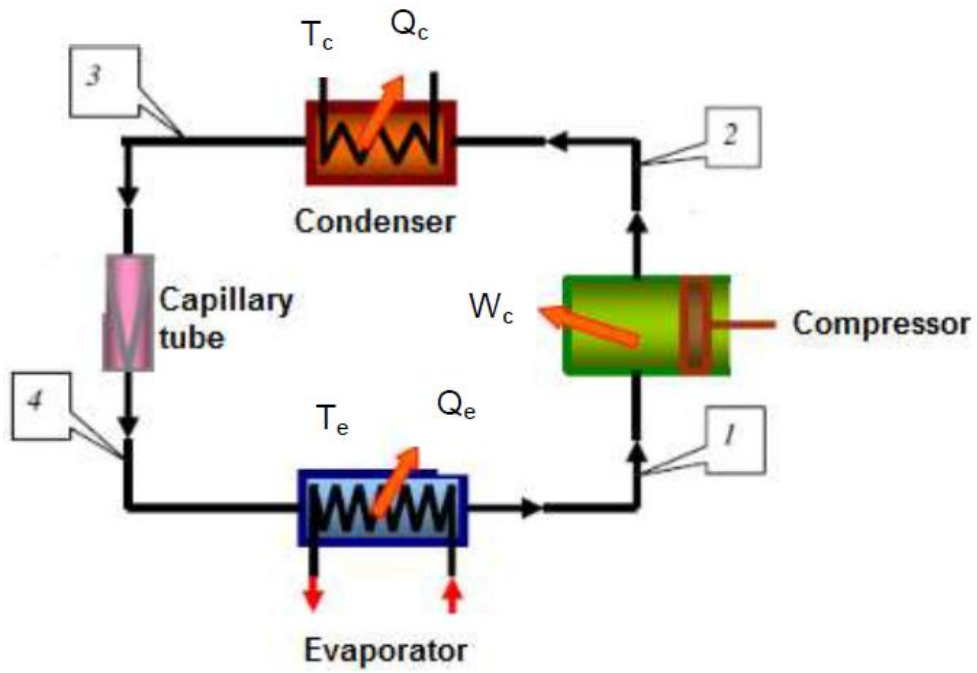

Fig. 1. Single stage vapour compression refrigeration system

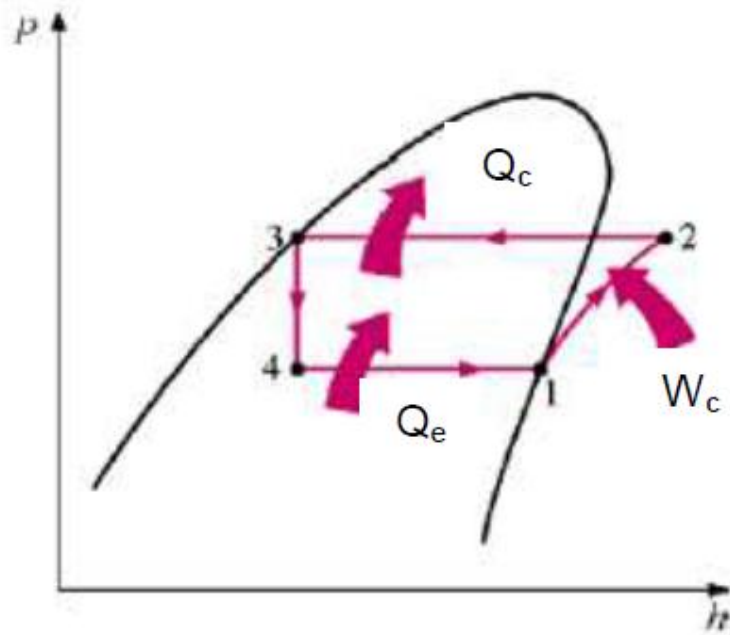

Fig. 2. P-h diagram vapour compression refrigeration system

$$Q_{BF} = mc_b(T_2 - T_3) \tag{6}$$

The detail of the terms ($n, m, T_2, c_a, c_b, h_{fg}$) for the selected products considered in the present study are shown in Table 1.

Table 1. Properties of the selected products

Products	Mass ,m [Kg]	Highest freezing temperature, T_2 [°C]	Specific heat above freezing, c_a [KJ/KgK]	Specific heat below freezing, c_b [KJ/KgK]	Latent heat of fusion, h_{fg} [KJ/KgK]
Apple	5	-1.5	3.64	1.88	506.26
Fresh meat	5	-1.67	3.18	2.13	418.40
Water	5	-0.3	3.94	2.01	310.24

Source: Heat load in refrigeration systems [11]

It is interesting to highlights that the average ambient temperature of the environment T_1 and the final temperature T_3 are assumed to be 30°C and -10°C respectively.

The infiltration load (Q_l) given in Eq. (1) is calculated from:

$$Q_l = 1.08V(T_1 - T_3) \quad (7)$$

where 1.08 is a multiplying factor and V is the average velocity of the door and is computed as:

$$V = v_r \sqrt{\frac{H}{H_r}} \sqrt{\frac{T_a}{T_r}} \quad (8)$$

where,

v_r is the average velocity of the reference door

H is the height of the door

H_r is the height of the reference door

T_a is the temperature difference between the refrigerated space and the environment

T_r is temperature difference of the reference door.

In the present study, the concept of energy balance in thermodynamics cycles, applying first Law of thermodynamics for control volumes to obtain performance result that can meet the operating conditions imposed on each component shown in Fig. 1 was adopted and is mathematically expressed according to Eq. (9)

$$\dot{Q}_{VC} + \sum \dot{m}_o \left(h_o + \frac{v_o^2}{2} + gz_o \right) = \frac{dE_{VC}}{dt} + \sum \dot{m}_i \left(h_i + \frac{v_i^2}{2} + gz_i \right) + \dot{W}_{VC} \quad (9)$$

Where the subscripts i and o in Eq. (9) stands for inlet and outlet states, respectively.

It is well known that in vapour compression refrigeration system, changes in kinetic, $v^2/2$ and potential energies, gz are negligible. Thus Eq. (9) becomes:

$$\dot{Q}_{VC} - \dot{W}_{VC} = \sum \dot{m}_o h_o + \sum \dot{m}_i h_i \quad (10)$$

Referring to the P-h diagram shown in Fig. 2 and application of Eq. (10) to each component of the system, the mathematical equations used to obtain the energy balance in each component are presented in the next subsections:

3.2 Heat Exchangers Models: Evaporator, Condenser

The heat absorbed by the evaporator (i.e., cooling capacity) is calculated from:

$$Q_e = \dot{m}(h_1 - h_4) \quad (11)$$

The heat released by the condenser is computed according to Eq. (12) as follows:

$$Q_c = \dot{m}(h_2 - h_3) \quad (12)$$

3.3 Compressor

An overall energy balance applied to calculate the rate of work input to the compressor is expressed mathematically as:

$$W_c = \dot{m}(h_2 - h_1) \quad (13)$$

3.4 Expansion Valve

For the expansion process, the overall energy balance in the capillary tube is calculated from:

$$\dot{m} h_3 = \dot{m} h_4 \quad (14)$$

The refrigerant mass flow rate (\dot{m}) of the systems is calculated from:

$$\dot{m} = \frac{Q_{CL}}{h_1 - h_4} \quad (15)$$

The Mathematical model described above was implemented in MATLAB [1] software to predict the response of principles components i.e compressor, condenser, expansion valve (capillary tube) and evaporator. The simulation model of the single stage vapour compression refrigeration system shown in Fig.1 was devised assuming the following conditions (i) the refrigeration system operates at steady state regime, (ii) irreversibilities within the evaporator, condenser and compressor are ignored, (iii) no frictional pressure drops, (iv) refrigerant flows at constant pressure through the two heat exchangers (evaporator and condenser), heat loss to the surrounding are ignored and compression process is isentropic. The solution algorithm is illustrated in the information flow diagram depicted in Fig. (3).

The software input data are refrigerant type, product properties, evaporation temperature and condensation temperature. The thermodynamics parameters (P, h, v, s) for the refrigerants considered were set from COOLPACK saturation table [12]. The first simulation of the system was performed using the thermodynamic properties of R12. Subsequently, new simulations were carried out for other refrigerants such as R22, R134a, R600a, R290, and ammonia considering their respective thermodynamic properties. It is interesting to point out that the effect of quantity of products refrigerated on the performance of vapour compression refrigeration system can be evaluated with the developed model taking into consideration Eqns. 1-8 thus, the performance prediction and optimum design of refrigeration systems can be achieved with this model.

Based on the simulation procedure carried out for each refrigerant, the performance of the system is evaluated as follows:

The coefficient of performance (COP) of the system is calculated from:

$$COP_{Re f} = \frac{Q_e}{W_c} \quad (16)$$

The overall efficiency of the system (η) is estimated from:

$$\eta = \frac{COP_{Re f}}{COP_{Carnot}} \quad (17)$$

The term COP_{Carnot} in Eq. (17) is calculated as follow:

$$COP_{Carnot} = \frac{T_e}{T_e - T_c} \quad (18)$$

where, T_e and T_c are the evaporation and condensation temperature respectively.

4. RESULTS AND DISCUSSION

In this section, analysis of performance of HCs, R134a, and ammonia as refrigerants in a single stage vapour compression refrigeration system based on the use of numerical model developed for the system are comparatively reported with those of R12 and R22 refrigerants. Simulation data was generated over a wide range of evaporator and condenser temperatures -25 to 15°C and 30 to 60°C respectively for various working fluids such as R12, R22, R134a, R290, R600a and ammonia to observe the performance of the system in terms of refrigerating effect, coefficient of performance (COP) and overall efficient of the system.

4.1 Comparative Analysis

An overview of the performance evaluation of the system based on the effects of evaporation and condensation temperatures using the selected refrigerants as working fluid in vapour compression refrigeration system are shown in Figs. 4-7. Fig. 4 presents the variation of coefficient of performance with the evaporation temperature at 40°C condenser temperature. Evaluating the Fig. 4, it is clear that the COP which is an important parameter in the analysis of cooling systems like vapour compression refrigeration system increases as expected with increasing the evaporation temperatures of the system. This behaviour is similar to those observed in the study of Mogaji and Yinusa [13]. Close match of COP values for R600a is observed with that of R12 and R22 counterpart under the similar operating conditions considered in the present study. It can also be noticed that for the same capacity compressor, COP of R134a and R290 is less than that of R12 and R22. However, among the refrigerants used in the simulated system under the similar operating

conditions, the system with the use of ammonia yields highest COPs and are of up to 6.3 and 7.5% increment compared with those of R12 and R22 respectively.

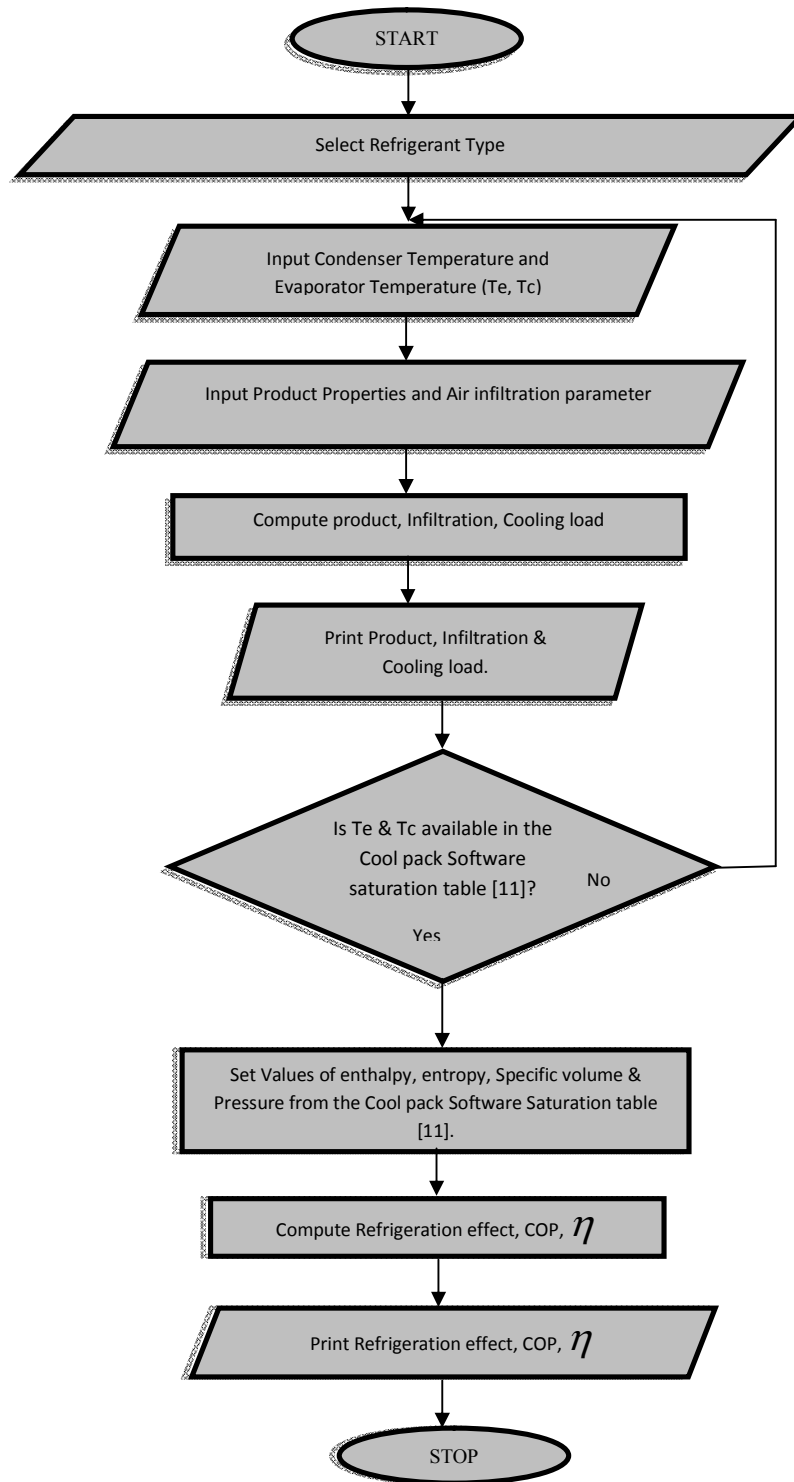

Fig. 3. Flow chart of the simulation program

The effects of condensation temperatures on the COP of the system at -10°C evaporator temperature using the selected refrigerants considered in the present study as shown in Fig. 5 revealed that the COP for the system decrease as the condensation temperature increases. This trend is similar to those observed in the studies of Mogaji and Yinusa [13] and Elgendy [14]. From Fig. 5, it can be observed that the COP value was nearly invariable among the systems simulated with the use of R12, R22, R290 and R600a. However, the simulated system with ammonia gave highest COP value as similarly observed in the study of Kilicarslan and Muller [15] and the COP value is of about 6 and 4 at condensation temperatures of 30 and 50°C respectively. These results also revealed that the system with the use of ammonia as a working fluid has the better performance compares with that of R12 and R22 under similar operating conditions. Simulation of the system with the use of R290 and R600a also showed better performance compared with other refrigerants considered in this study from the effect of condensation temperature on the system refrigerating effect point of view as shown in Figs. 6 and 7. It can also be noticed from these figures that the performance of the system with the use of R134a is relatively close to those of the systems with R12 and R22. It is interesting to highlight that the performance evaluation simulation results for ammonia in terms of refrigerating effect though not shown in Fig. 6 and 7 is on a high side compared to the other refrigerants considered in this study.

The overall efficiency results of the simulated system with the use of the selected refrigerants obtained using Eq. (17) by taking into consideration the effects of evaporation and

condensation temperatures on the system are presented in Tables 2 and 3. The results contained in Tables 2 and 3 also revealed that the overall efficiency of the system with R12, R22, R134, R290 and R600a are nearly matching the same values. However, the use of ammonia under the same operating condition gave the highest overall efficiency of the system. For the ammonia, the simulation resulted in overall efficiency for about 84 and 92% at high evaporation and condensation temperatures of 15 and 50°C respectively. These results justify the reason for better performance of the system with the use of ammonia among others refrigerants as displayed in Figs. 4 and 5.

The results from this study revealed that R12 and R22 may be replaced by ammonia, R134a, R600a and R290 without any significant loss in the overall performance of vapour compression refrigeration system considering the fact that the impact of ammonia on ozone layer (ODP) and global warming potential (GWP) is null but based on its corrosive and toxic nature, it can be used by using safety measure for industrial applications, R134a is easily available in the market and its impact on the ozone layer is negligible compared with that of R12 and R22, also with the use of modern hermetically sealed system in refrigeration system, the problems of flammability posed by the use of hydrocarbons refrigerant are now reduced to some extent. Moreover, among the refrigerants comparatively analysed, the use of ammonia was the best working fluid for the vapour compression refrigeration system simulated in this study. This is because, the simulated system with ammonia presented the best COP and highest overall efficiency of the system compared with other refrigerants considered in this work.

Table 2. Effects of evaporation temperatures on the overall efficiency the simulated system

Tevap [$^{\circ}\text{C}$]	R12 η [%]	R22 η [%]	R134a η [%]	R290 η [%]	R600a η [%]	ammonia η [%]
-25	73.7	74.2	70.4	69.5	71.9	83.6
-20	75.5	76.1	72.7	71.6	74.0	85.1
-15	77.3	77.5	74.6	73.3	76.0	86.0
-10	79.1	79.3	76.6	75.4	78.0	87.5
-5	80.7	80.5	78.5	77.0	80.0	88.4
0	82.5	82.3	80.5	79.0	82.0	89.8
5	84.2	83.5	82.3	81.1	84.0	90.5
10	85.8	85.4	84.3	82.9	86.0	91.9
15	87.5	86.4	86.3	84.8	88.0	92.6

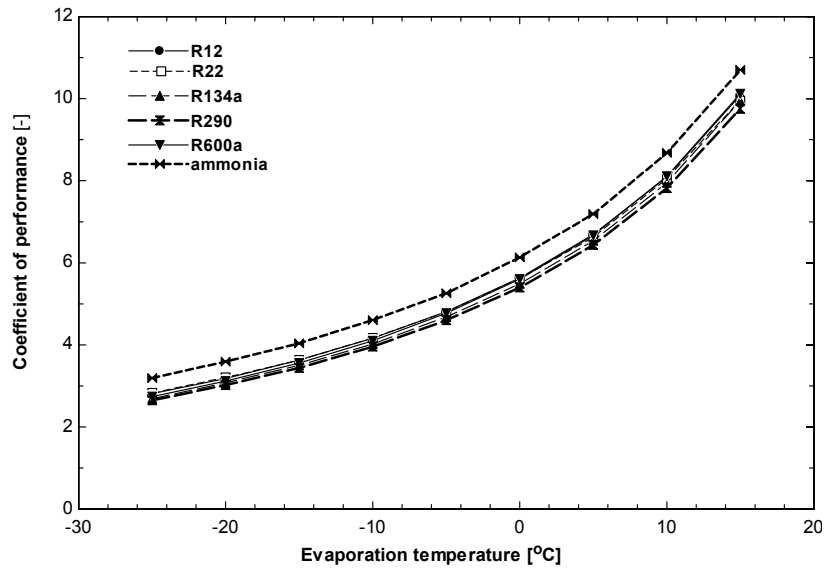

Fig. 4. Variation of coefficient of performance with evaporation temperature

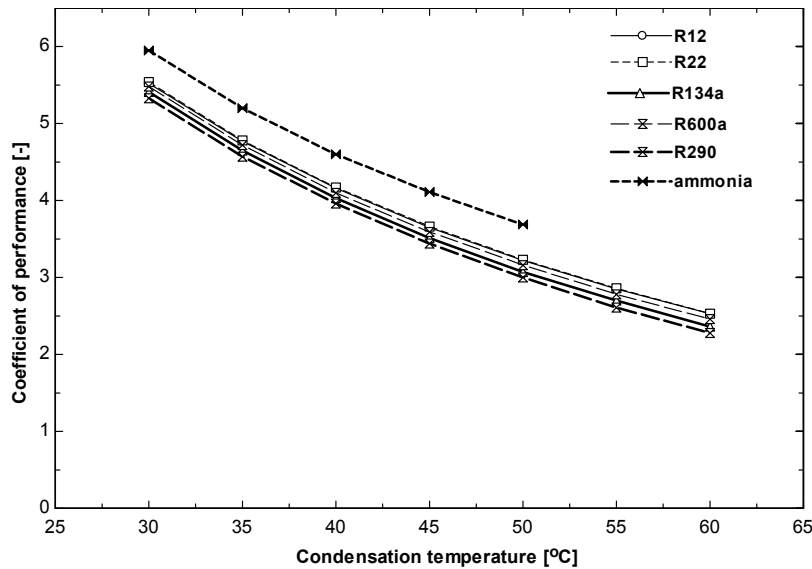

Fig. 5. Variation of coefficient of performance with condensation temperature

Table 3. Effects of condensation temperatures on the overall efficiency of the simulated system

Tcond [°C]	R12 η [%]	R22 η [%]	R134a η [%]	R290 η [%]	R600a η [%]	Ammonia η [%]
30	84.0	84.3	82.2	81.4	83.4	90.5
35	81.6	81.9	79.5	78.2	80.8	89.0
40	79.1	79.3	76.6	75.4	78.0	87.5
45	76.4	76.6	73.5	72.0	75.1	85.7
50	73.5	73.7	70.1	68.4	72.1	84.2

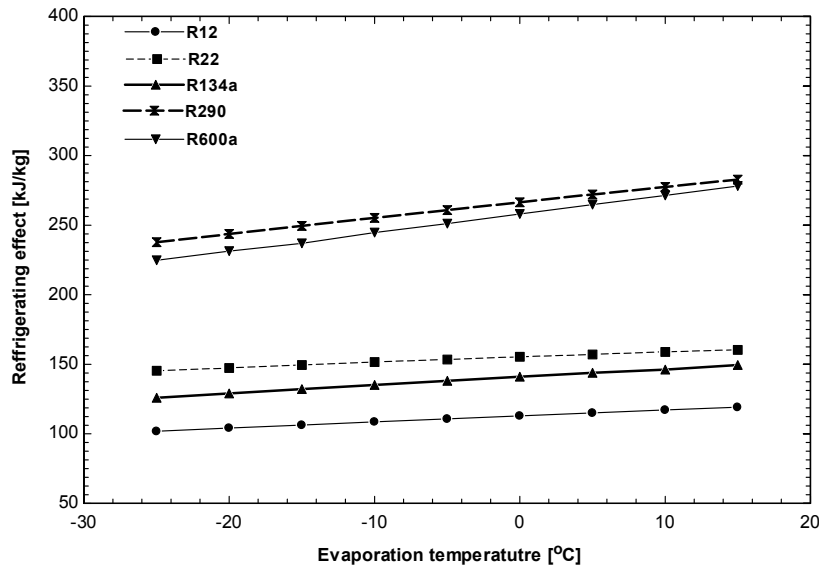

Fig. 6. Variation of refrigerating effect with evaporation temperature

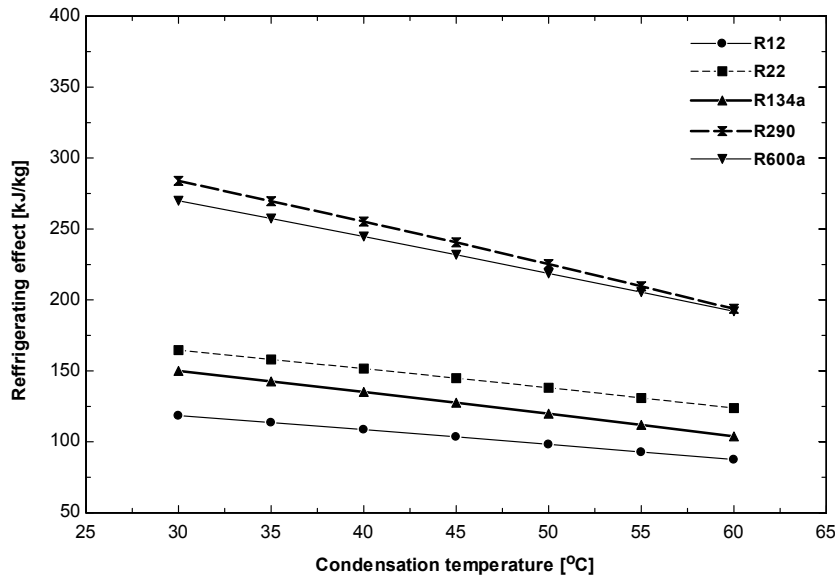

Fig. 7. Variation of refrigerating effect with condensation temperature

5. CONCLUSION

Analyses of performance of Hydrocarbons (HCs), R134a, and ammonia as refrigerants in a single stage vapour compression refrigeration system based on the use of simulation model developed for the system are comparatively reported with those of R12 and R22 refrigerants in this paper. Performance evaluation of the system was characterized in terms of coefficient of performance (COP), refrigerating effect and overall efficiency of the system using the various selected working fluid considered in this work.

The effects of condensation and evaporation temperatures were studied on the system operation and performances. From the present study, the following main conclusions can be drawn:

- i. The COP and Refrigerating effect of the vapour compression refrigeration system increase with increasing the evaporation temperatures and decreasing the condensation temperatures of the system.

- ii. Close match of COP and the system overall efficiency values for, R134, R290 and R600a are observed with that of R12 and R22 counterpart under the similar operating conditions.
- iii. Among the refrigerants simulated in the system under the similar operating conditions, the system with the use of ammonia yields highest COPs and are of up to 6.3 and 7.5% increment compared with those of R12 and R22 respectively.
- iv. Ammonia was observed to be the best working fluid for the vapour compression refrigeration system presented the best COP and highest overall efficiency of the system compares with other refrigerants considered in this study.
- v. According to the preceding comparative analysis on performance evaluation of vapour compression refrigeration system. It can be concluded that R12 and R22 may be replaced by ammonia, R134a, R600a and R290 without any significant loss in the overall performance of the system provided the safety issues are addressed in terms of manufacturing, handling, storage and servicing so as to prevent flammability and corrosive/toxic nature of hydrocarbons and ammonia respectively.

ACKNOWLEDGMENTS

The author would like to acknowledge the assistance of the Refrigeration and Air Conditioning Unit of the Department of Mechanical Engineering, Federal University of Technology Akure in supplying the needed information used in the present study.

COMPETING INTERESTS

Author has declared that no competing interests exist.

REFERENCES

1. MATLAB R2012a. Available: www.mathworks.com/patents
2. Mohan C. Exergy analysis of vapour compression refrigeration system using R12 and R134a as refrigerants. International Journal of Students Research in Technology & Management. 2014;134-139.
3. Dalkilic AS, Wongwises S. Performance comparison of vapour compression refrigeration system using various alternative refrigerants. International Communication in Heat and Mass Transfer. 2010;1340-1349.
4. Kalla SK, Usmani JA. Alternative Refrigerants: A Review. International Journal of Engineering Sciences & Research Technology. 2014;397-401.
5. Guo-liang Ding. Recent developments in simulation techniques for vapour-compression refrigeration systems. International Journal of Refrigeration. 2007;1119-1133.
6. Sanaye S, Malekmohammadi HR. Thermal and economical optimization of air conditioning units with vapour compression refrigeration system. Journal of Applied Thermal Engineering. 2004;1807-1825.
7. Winkler J. Development of a component based simulation tool for steady-state and transient analysis of vapour compression systems. Ph. D Thesis, Department of Mechanical Engineering, University of Maryland, College Park, MD; 2009.
8. Raghunatha Reddy DV, Bhramara P, Govindarajulu K. Application of soft computing techniques for analysis of vapour compression refrigeration system. International Journal of Current Engineering and Technology. 2014;368-373.
9. Tallita KN, Luciana CM, José VCV. Transient modelling and simulation of a vapour compression system for comparison of refrigerants fluids. 22nd International Congress of Mechanical Engineering (COBEM 2013), Ribeirão Preto, SP, (Brazil). 2013;6046-6049.
10. Hadya B, Usha Sri P, Suresh A. Comparative Study of Eco-friendly refrigerants in a lower capacity air-conditioning system. International Conference on Mechanical and Automotive Engineering (ICMAE'2012) September 8-9, Bangkok (Thailand). 2012;48-51.
11. Ebook manual file on Heat load in refrigeration system's by Roger D. Holder, CM, MSME. 32-37.
12. Arne J, Bjarne DR, Morten JS, Simon EA. COOPACK Technical University of Denmark Mechanical Engineering, Lyngby, Denmark. 2004;46.
13. Mogaji TS, Yinusa RK. Performance evaluation of vapour compression refrigeration system using double effect condensing unit (Sub-cooler). International

- Journal of Engineering and Technology Sciences. 2015;3(1):55-64.
14. Elgendy E. Parametric study of a vapour compression refrigeration cycle using a two-phase constant area ejector. International Journal of Mechanical, Aerospace, Industrial and Mechatronics Engineering. 2013;7(8):1-7.
15. Ali Kilicarslan A, Muller N. A comparative study of water as a refrigerant with some current refrigerants. International Journal of Energy Research. 2005;29:947–959.

© 2015 Mogaji; This is an Open Access article distributed under the terms of the Creative Commons Attribution License (<http://creativecommons.org/licenses/by/4.0>), which permits unrestricted use, distribution, and reproduction in any medium, provided the original work is properly cited.

Peer-review history:

The peer review history for this paper can be accessed here:
<http://www.sciencedomain.org/review-history.php?iid=1074&id=5&aid=9151>